

SCRIVENER DAM



Scrivener Dam holds back the waters of the Molonglo River to create Lake Burley Griffin in the heart of the National Capital. Prior to construction, a fully functioning scale model of the lake was created to investigate water flow, silt deposits, erosion and dam capacity - particularly during the habitual flooding of the Molonglo River. Areas likely to erode were then bolstered with rocks or planted with trees during construction of the lake. Being able to control water levels with a dam also prevents flooding in the capital.

[TOP LEFT] Scale model of the dam made by Peter De Vogel and used in the working model of the proposed lake.

[TOP RIGHT] Construction works, 1962.

[BOTTOM] Releasing water after heavy rain in 2002 with one of the five flap gates open.

BLOCK
FACTS

The dam wall is 33 metres high and 319 metres long. Its wall also provides a roadway, called Lady Denman Drive. This is only possible because the dam gates are closed by pushing up from below, unlike earlier dam designs where the gates were lifted from above.

BASE LAYER

Use this guide to accurately lay out your first layer of bricks:

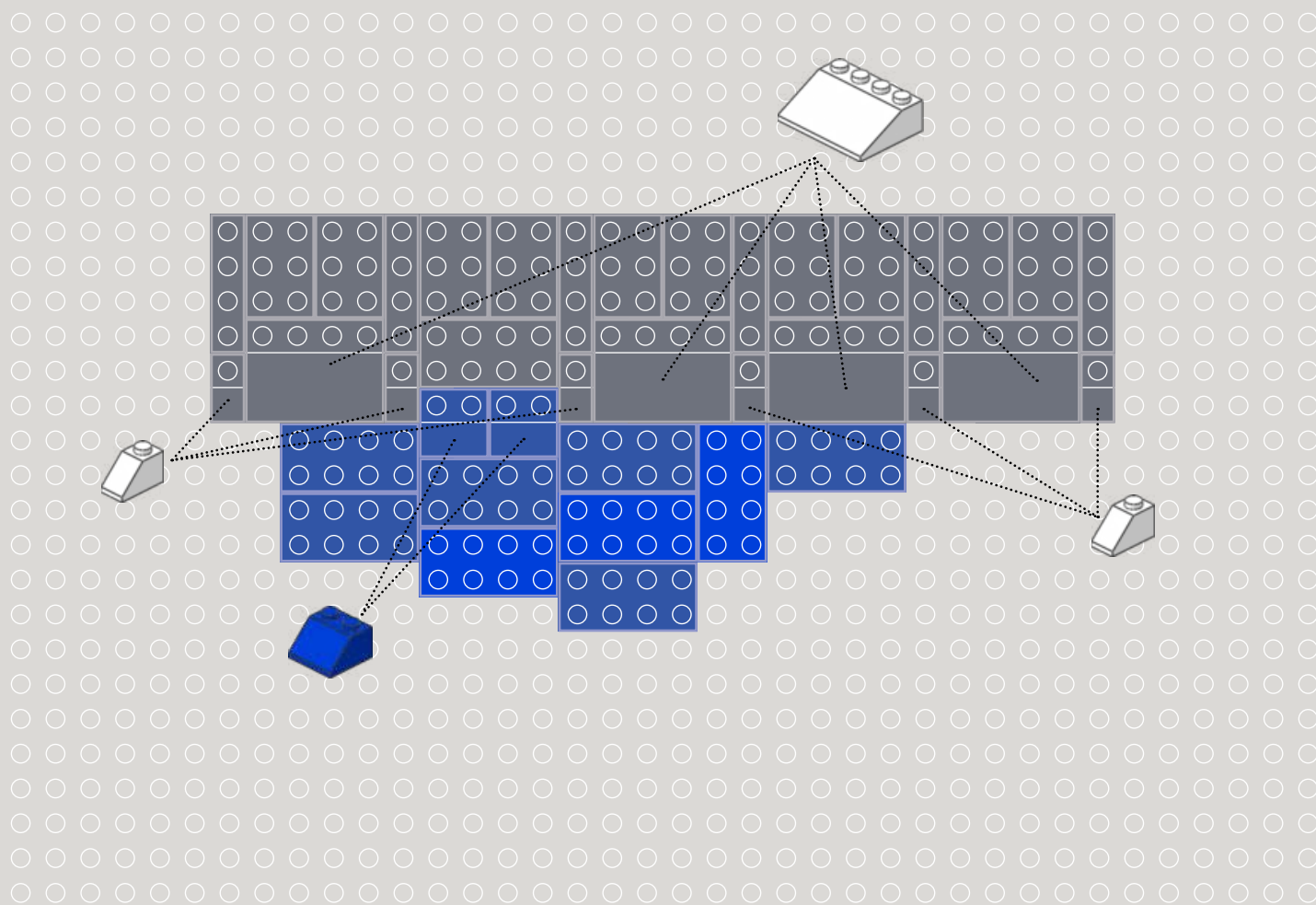

PARTS LIST

You will need:

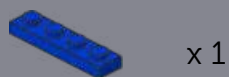

x 1



x 6



x 6



x 6

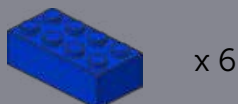

x 6

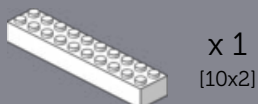

x 1
[10x2]

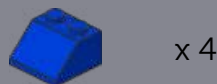

x 4



x 8



x 1

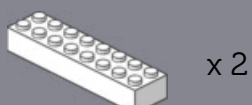

x 2



x 18

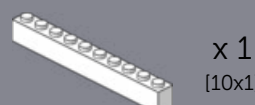

x 1
[10x1]



x 10

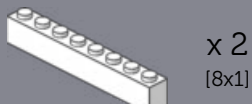

x 2
[8x1]



x 4

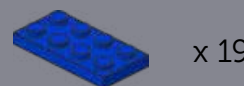

x 19

SCRIVENER DAM

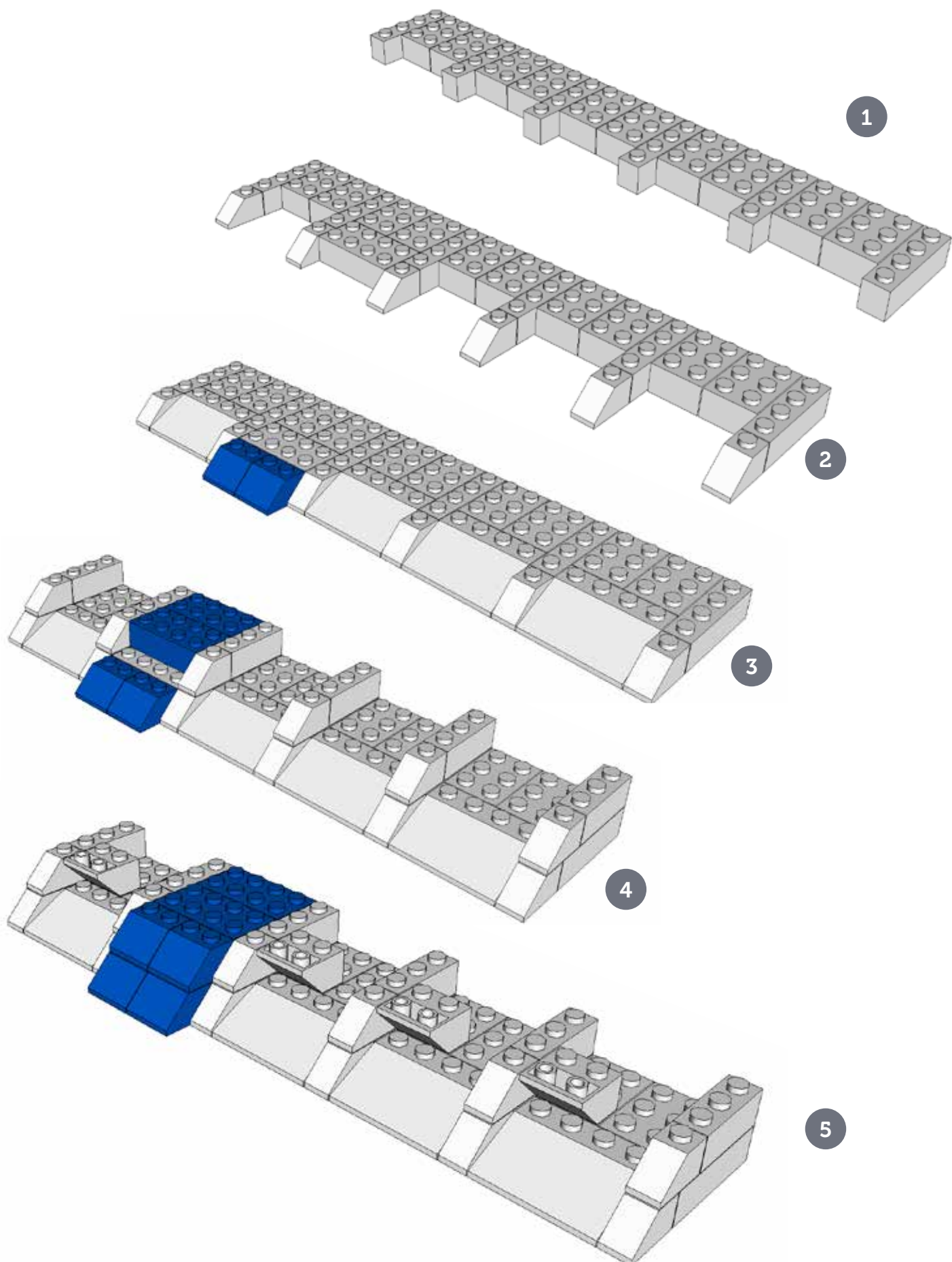

6

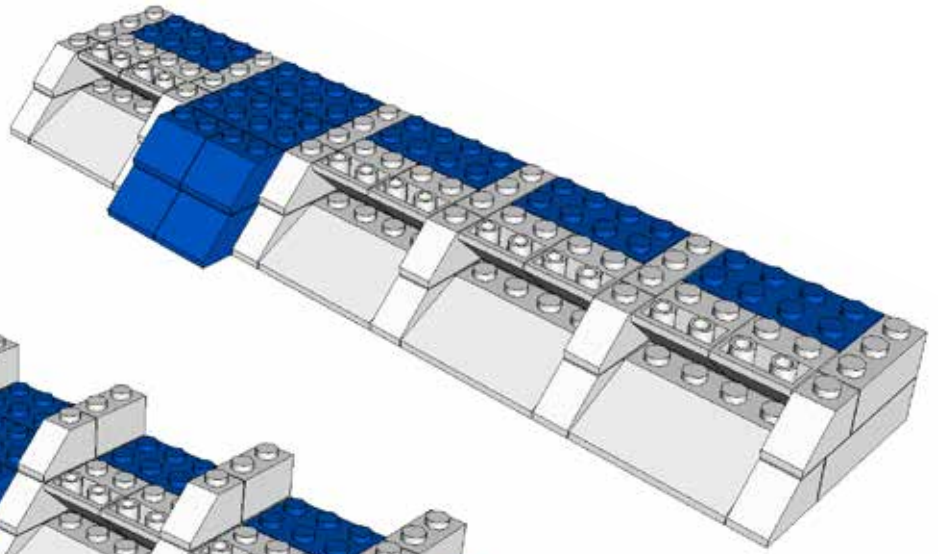

7

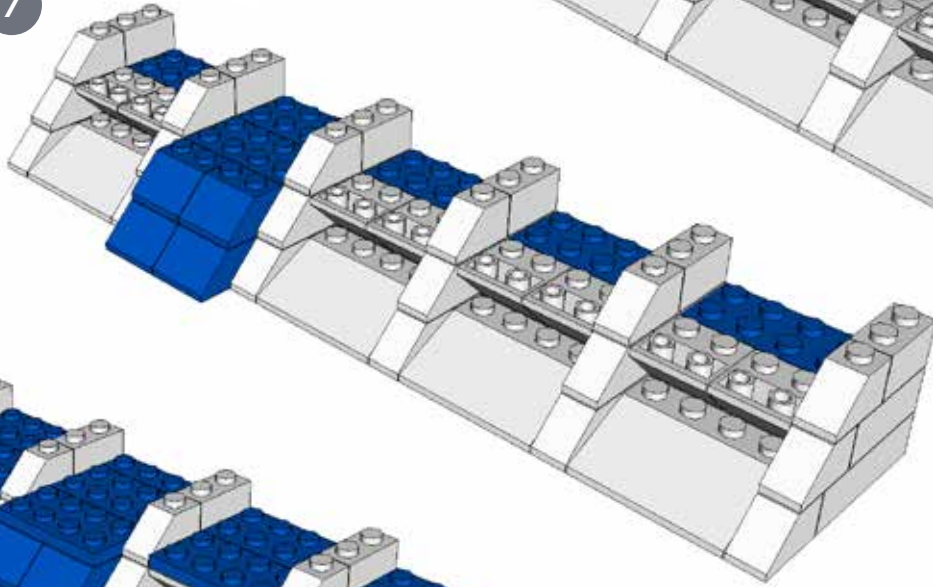

8

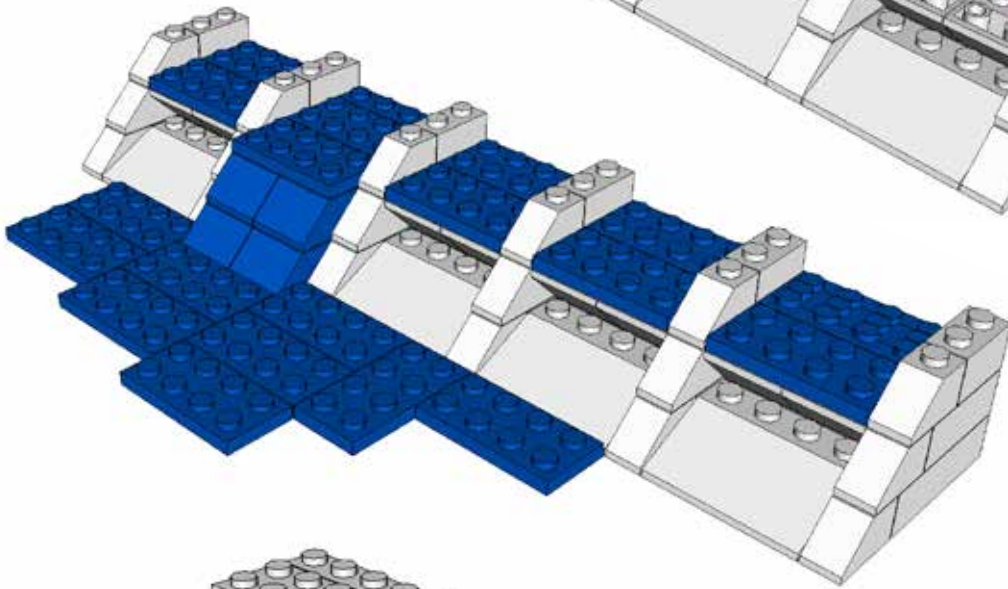

9

